

R82 Flamingo

USD Retail Price List/ Order Form

Account #: _____ Purchase Order No.: _____ Date: _____
 Contact: _____ Mark For: _____

Bill To:	Ship To:
Address:	Address:
City/State/Zip:	
Phone:	City/State/Zip:
Email	Phone:

US Configuration

Effective: 01.10.24 - Rev 8

- Flamingo/Flamingo High-low
- Head support
- Push handle/push brace
- Side supports
- Arm rest/tray
- Commode pan/potty ring
- Vests and belts



A (Back height) _____
 B (Arm height) _____
 C (Lower leg length) _____
 D (Seat depth) _____
 E (Chest width) _____
 F (Seat width) _____
 G (Height from seat to top of head) _____
 H (Shoulder width) _____
 Age _____
 Weight _____

Flamingo Measurements

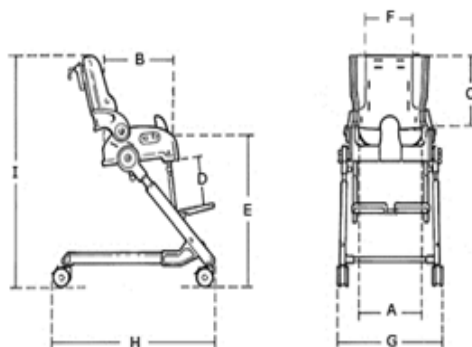

	Size 1 Inches	Size 2 Inches	Size 3 Inches	Size 4 Inches
Seat width (A)	9¼"	11"	12½"	13¼"
Seat depth (B)	9¾"	11¼"	13¾"	15½"
Back height (C)	13¾"	14¾"	16½"	18¼"
Lower leg length (D)	7-10"	9¾-13½"	11¾-15½"	11¾-15½"
Seat height (E)*	19½-23½"	19½-23½"	19½-23½"	19½-23½"
Back width (F)	7¾"	8½"	10¼"	11½"
Width, frame (G)	17"	18"	19¼"	21"
Length, frame (H)*	26"	26"	26"	26"
Height, frame w/seat (I)*	33½"	35"	36½"	37"
Seat height, folded	9½"	10"	10½"	10½"
Seat length, folded	14½"	15½"	17"	18½"
Frame height, folded	8"	8"	8"	8"
Frame length, folded	29"	29"	29"	29"
Weight	24 lbs.	29 lbs.	31 lbs.	33 lbs.
Max. Load/user weight	77 lbs.	110 lbs.	132 lbs.	154 lbs.
Angling	Seat	-15°-+35°	Back	-90°-30°
	Foot support bar			90°-60°

* with 3" wheels

Flamingo High-Low Measurements

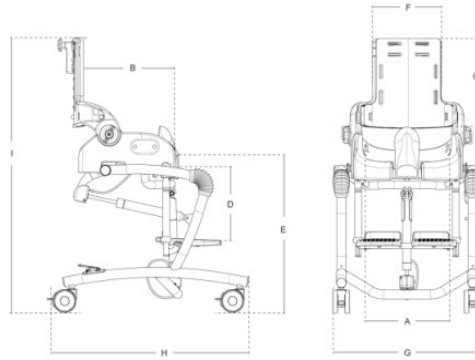

	Size 1 Inches	Size 2 Inches	Size 3 Inches	Size 4 Inches
Seat width (A)	24 (9¼)	28 (11)	32 (12½)	34 (13¼)
Seat depth (B)	25 (9¾)	29 (11¼)	35 (13¾)	40 (15½)
Back height (C)	35 (13¾)	38 (14¾)	42 (16½)	47 (18¼)
Lower leg length (D)	20-25 (7¼-9¾)	23-34 (9-13¼)	30-42 (11¾-16½)	30-42 (11¾-16½)
Seat height above floor (E)	53-74 (20¾-28¾)	53-74 (20¾-28¾)	53-74 (20¾-28¾)	53-74 (20¾-28¾)
Back width (F)	20 (7¼)	22 (8½)	26 (10¼)	28 (11)
Frame width (G)	50 (19½)	50 (19½)	57 (22¼)	57 (22¼)
Frame length (H)	64 (25)	64 (25)	76 (29½)	76 (29½)
Total height (I)	86-108 (33½-42)	92-111 (35¾-43¼)	94-117 (36¾-45¾)	102-120 (39¾-46¾)
Seat, total width	35 (13¾)	38 (14¾)	43 (16¾)	48 (18¾)
Seat, total depth	26 (10¼)	31½ (12¼)	36 (14)	42½ (16½)
Seat, total height	40 (15½)	43 (16¾)	48 (18¾)	51 (19¾)
Back angling	-90°-+30°	-90°-+30°	-90°-+30°	-90°-+30°
Tilt in space	-5°-+20° *	-5°-+20°	-5°-+20°	-5°-+20°
Foot support angle	90°-75°	90°-75°	90°-75°	90°-75°
Weight, total	14 kg (31 lb)	14.5 kg (32 lb)	16.5 kg (36.5 lb)	17 kg (37.5 lb)
Weight, frame	11.5 kg (25.5 lb)	11.5 kg (25.5 lb)	12.5 kg (27.5 lb)	12.5 kg (27.5 lb)
Weight, seat	2.5 kg (5.5 lb)	3 kg (6.5 lb)	4 kg (9 lb)	4.5 kg (10 lb)
Max. load, total	35 kg (77 lb)	50 kg (110 lb)	60 kg (132 lb)	70 kg (154 lb)
Max. load, seat	35 kg (77 lb)	50 kg (110 lb)	60 kg (132 lb)	70 kg (154 lb)
Max. load, operating force	35 kg (77 lb)	35 kg (77 lb)	55 kg (121 lb)	55 kg (121 lb)

* The -5° tilt is obtainable at 55 cm (19½") seat height above floor

Flamingo Standard Features

- Size 1, 2, 3 and 4
- 4 White Castors with Lock
- Aluminum Frame
- 100% Waterproof Upholstery for Seat and Back
- Height Adjustable and Foldable Frame
- Tilt n' Space (+5° to -35°)
- Recline Back
- Active Back (No Sides)
- Splash Guard - High Model

Flamingo High-Low Standard Features

- Size 1, 2, 3 and 4
- 4 White Castors with Lock
- Foot Support (High-Low Version Only)
- 100% Waterproof Upholstery for Seat and Back
- Height Adjustable Frame
- Tilt n' Space (+5° to -35°)
- Recline Back
- Active Back (No Sides)
- Splash Guard - High Model

Flamingo Seat & Back	Description	Size	Part No.	USD Price	HPCPS
----------------------	-------------	------	----------	-----------	-------



<input type="checkbox"/>	Flamingo Seat and Back, Blue ●●	1	880101-61	\$589	
<input type="checkbox"/>	Flamingo Seat and Back, Blue ●●	2	880102-61	\$589	
<input type="checkbox"/>	Flamingo Seat and Back, Blue	3	880103-61	\$589	
<input type="checkbox"/>	Flamingo Seat and Back, Blue	4	880104-61	\$642	
<input type="checkbox"/>	Flamingo Seat and Back, Gray	1	880101	\$707	
<input type="checkbox"/>	Flamingo Seat and Back, Gray	2	880102	\$707	
<input type="checkbox"/>	Flamingo Seat and Back, Gray	3	880103	\$707	
<input type="checkbox"/>	Flamingo Seat and Back, Gray	4	880104	\$707	

IMPORTANT: No returns or exchanges accepted for this product

Flamingo Frame	Description	Size	Part No.	USD Price	HCPCS
----------------	-------------	------	----------	-----------	-------



Note: Footrest not included with Flamingo Frame

<input type="checkbox"/> Flamingo Frame with 3" Castors		1	880201-NL	\$695	
<input type="checkbox"/> Flamingo Frame with 3" Castors		2	880202-NL	\$695	
<input type="checkbox"/> Flamingo Frame with 3" Castors		3	880203-NL	\$695	
<input type="checkbox"/> Flamingo Frame with 3" Castors		4	880204-NL	\$802	

Note: Select foot support only if using standard frame,

<input type="checkbox"/> Flamingo Foot Support (Pr.)		1	880211	\$214	
<input type="checkbox"/> Flamingo Foot Support (Pr.)		2	880212	\$214	
<input type="checkbox"/> Flamingo Foot Support (Pr.)		3	880213	\$214	
<input type="checkbox"/> Flamingo Foot Support (Pr.)		4	880214	\$214	



<input type="checkbox"/> Calf Support	H:3.9" x L:41.7"	One Size	880199	\$71	
<input type="checkbox"/> Footrest Straps, Pair			85096	\$39	

High-Low Bath Frame	Description	Size	Part No.	USD Price	HCPCS
---------------------	-------------	------	----------	-----------	-------

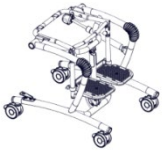

Note: foot support is standard with high-low frame

<input type="checkbox"/> High-low Bath Frame with 4" Castors		1	880411	\$2,364	
<input type="checkbox"/> High-low Bath Frame with 4" Castors		2	880412	\$2,364	
<input type="checkbox"/> High-low Bath Frame with 4" Castors		3	880413	\$2,364	
<input type="checkbox"/> High-low Bath Frame with 4" Castors		4	880414	\$2,429	

Potty Frame	Description	Size	Part No.	USD Price	HCPCS
-------------	-------------	------	----------	-----------	-------



<input type="checkbox"/> Potty Frame	H:7 1/2"-9 1/4"	1	880160-1	\$401	
<input type="checkbox"/> Potty Frame	H: 9 3/4"-11 1/2"	2	880160-2	\$401	

Pelvic Positioning	Description	Measurements	Size	Part No.	USD Price	HCPCS
--------------------	-------------	--------------	------	----------	-----------	-------



<input type="checkbox"/> Upholstery, Seat w/wide sides, Blue			2	880166-61	\$113	
<input type="checkbox"/> Upholstery, Seat w/wide sides, Blue			3	880167-61	\$118	
<input type="checkbox"/> Upholstery, Seat w/wide sides, Blue			4	880168-61	\$123	

<input type="checkbox"/> Upholstery, Seat w/wide sides, Gray			2	880166	\$176	
<input type="checkbox"/> Upholstery, Seat w/wide sides, Gray			3	880167	\$176	
<input type="checkbox"/> Upholstery, Seat w/wide sides, Gray			4	880168	\$176	



<input type="checkbox"/> Seat Infill for Seat, Blue			1	880185-61	\$58	
<input type="checkbox"/> Seat Infill for Seat, Blue			2	880186-61	\$58	
<input type="checkbox"/> Seat Infill for Seat, Blue			3	880187-61	\$65	
<input type="checkbox"/> Seat Infill for Seat, Blue			4	880188-61	\$65	

<input type="checkbox"/> Seat Infill for Seat, Gray			1	880185	\$108	
<input type="checkbox"/> Seat Infill for Seat, Gray			2	880186	\$108	
<input type="checkbox"/> Seat Infill for Seat, Gray			3	880187	\$108	
<input type="checkbox"/> Seat Infill for Seat, Gray			4	880188	\$108	

Description	Measurements	Size	Part No.	USD Price	HCPCS
-------------	--------------	------	----------	-----------	-------



<input type="checkbox"/> Seat Belt w/ Plastic Lock		One Size	85100	\$33	
<input type="checkbox"/> Suction Cups for Seat		One Size	880150	\$144	



<input type="checkbox"/> Splashguard, Low Profile, Blue	3" x 3 1/2" x 2 1/2"	1	880195-61	\$82	
<input type="checkbox"/> Splashguard, Low Profile, Blue	4" x 3" x 2 1/2"	2,3,4	880196-61	\$82	
<input type="checkbox"/> Splashguard, Low Profile, Gray	3" x 3 1/2" x 2 1/2"	1	880195	\$82	
<input type="checkbox"/> Splashguard, Low Profile, Gray	4" x 3" x 2 1/2"	2, 3, 4	880196	\$82	



Description	Measurements	Size	Part No.	USD Price	HCPCS
<input type="checkbox"/> Splashguard, High Profile, Blue		1	880191-61	\$87	
<input type="checkbox"/> Splashguard, High Profile, Blue		2,3,4	880192-61	\$87	
<input type="checkbox"/> Splashguard, High Profile, Gray		1	880191	\$87	
<input type="checkbox"/> Splashguard, High Profile, Gray		2,3,4	880192	\$87	

Trunk Positioning

Description	Measurements	Size	Part No.	USD Price	HCPCS
-------------	--------------	------	----------	-----------	-------

Note: Cannot be used with swing-away lateral supports

<input type="checkbox"/> Sides for Back w/ Upholstery, Blue (E)*		1	880111-61	\$138	
<input type="checkbox"/> Sides for Back w/ Upholstery, Blue (E)*		2	880112-61	\$138	
<input type="checkbox"/> Sides for Back w/ Upholstery, Blue (E)*		3	880113-61	\$138	
<input type="checkbox"/> Sides for Back w/ Upholstery, Blue (E)*		4	880114-61	\$151	



<input type="checkbox"/> Sides for Back w/ Upholstery, Gray (E)*		1	880111	\$289	
<input type="checkbox"/> Sides for Back w/ Upholstery, Gray (E)*		2	880112	\$289	
<input type="checkbox"/> Sides for Back w/ Upholstery, Gray (E)*		3	880113	\$289	
<input type="checkbox"/> Sides for Back w/ Upholstery, Gray (E)*		4	880114	\$289	

(E)* Cannot be combined w/ Swing-Away Lateral Supports

<input type="checkbox"/> Vest, Water-Proof Mesh (Ea.)		0	89111-040	\$214	
<input type="checkbox"/> Vest, Water-Proof Mesh (Ea.)		¾	89111-07540	\$214	
<input type="checkbox"/> Vest, Water-Proof Mesh (Ea.)		1	89111-140	\$214	
<input type="checkbox"/> Vest, Water-Proof Mesh (Ea.)		2	89111-240	\$214	

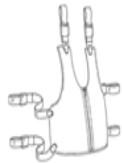

<input type="checkbox"/> H-Harness w/Plastic Lock			85105	\$65	
---------------------------------------------------	--	--	-------	------	--

<input type="checkbox"/> Back extension, grey	H:4"x L:8"	1,2	880118	\$182	
<input type="checkbox"/> Back extension, grey	H:4"x L:10"	3,4	880119	\$182	
<input type="checkbox"/> Mounting Rod for Back Extension	L:8"		880120	\$49	



<input type="checkbox"/> Back Reinforcement Kit ♦		3, 4	880155	\$273	
---------------------------------------------------	--	------	--------	-------	--



♦ Recommended for children with high tone

Description	Measurements	Size	Part No.	USD Price	HCPCS
-------------	--------------	------	----------	-----------	-------

<input type="checkbox"/> Fixed side supports, incl. Gray Cover, set		1	88401-10	\$250	
<input type="checkbox"/> Fixed side supports, incl. Gray Cover, set		2	88401-20	\$250	



<input type="checkbox"/> Bar, Straight, Stainless (A)**			82569	\$0	
<input type="checkbox"/> Bar, Straight, Stainless (A)**			82648	\$0	



<input type="checkbox"/> Cushion, Curved, Blue, Each (B)**	L:5 ¾"xH:2 ½"		6075409	\$113	
<input type="checkbox"/> Cushion, Curved, Blue, Each (B)**	L:6 ½"xH:2 ½"		6075408	\$113	
<input type="checkbox"/> Cushion, Curved, Blue, Each (B)**	L:7 ½"xH:2 ¾"		6075407	\$113	
<input type="checkbox"/> Protection Pad Covers, Gray			89151	\$98	



<input type="checkbox"/> Swing-Away Bracket, Right, Each (C)**		A: 1¼", B:4¾'	83300-R	\$241	
<input type="checkbox"/> Swing-Away Bracket, Left, Each (C)**		A: 1¼", B:4¾'	83300-L	\$241	



<input type="checkbox"/> Swing-Away Bracket, Right, Offset (D)		A: 2¼", B: 5"	83500-R	\$241	
<input type="checkbox"/> Swing-Away Bracket, Left, Offset (D)		A: 2¼", B: 5"	83500-L	\$241	





(A), (B), (C) Required to complete Swing-Away Lateral Assy**



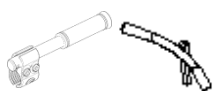

(E)* Cannot be combined w/ Swing-Away Lateral Supports

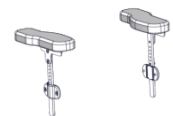

Description	Measurements	Size	Part No.	USD Price	HCPCS
-------------	--------------	------	----------	-----------	-------

<input type="checkbox"/> Push Brace		One Size	880110	\$102	
<input type="checkbox"/> Push Handle for High-Low Frame		1, 2	880110-HL	\$91	
<input type="checkbox"/> Push Handle for High-Low Frame		3, 4	880110-HLL	\$91	

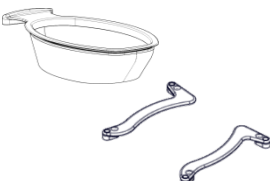

Head Support	Description	Measurements	Size	Part No.	USD Price	HCPCS	
	<input type="checkbox"/> Head Support No. 1, Blue PU			6071000	\$219		
	<input type="checkbox"/> Head Support No. 2, Blue PU			6072000	\$219		
	<input type="checkbox"/> Head Support No. 3, Blue PU			6073000	\$219		
	<input type="checkbox"/> Head Support No. 4, Blue PU			6074000	\$219		
	<input type="checkbox"/> Head Support No. 1, Gray PU			6171000	\$219		
	<input type="checkbox"/> Head Support No. 2, Gray PU			6172000	\$219		
	<input type="checkbox"/> Head Support No. 3, Gray PU			6173000	\$219		
	<input type="checkbox"/> Head Support No. 4, Gray PU			6174000	\$219		
	<input type="checkbox"/> Turtle Bar System, Short*	5"		98619-24	\$246		
	*Required to mount Head Support						

Accessories	Description	Measurements	Size	Part No.	USD Price	HCPCS
	<input type="checkbox"/> Swing-Away Amrest/Tray, Blue		1	880131-61	\$214	
	<input type="checkbox"/> Swing-Away Amrest/Tray, Blue		2	880132-61	\$214	
	<input type="checkbox"/> Swing-Away Amrest/Tray, Blue		3	880133-61	\$214	
	<input type="checkbox"/> Swing-Away Amrest/Tray, Blue		4	880134-61	\$214	
	<input type="checkbox"/> Separate armrests, Set	9"	one size	880152	\$161	
	*Cannot be used together with sides for back – 880111, 880111-61, 880112 and 880112-61					
	Commode pan w/holder, for Flamingo and					
	<input type="checkbox"/> Flamingo High-low sz. 1		1	880121	\$128	
	Commode pan w/holder, for Flamingo and					
	<input type="checkbox"/> Flamingo High-low sz. 2		2	880122	\$128	
	Commode pan w/holder, for Flamingo and					
	<input type="checkbox"/> Flamingo High-low sz. 3		3	880123	\$128	
	Commode pan w/holder, for Flamingo and					
	<input type="checkbox"/> Flamingo High-low sz. 4		4	880124	\$128	
	<input type="checkbox"/> Potty ring w/holders		1	880121-PR	\$138	
	<input type="checkbox"/> Potty ring w/holders		2	880122-PR	\$138	
	<input type="checkbox"/> Potty ring w/holders		3	880123-PR	\$138	
	<input type="checkbox"/> Potty ring w/holders		4	880124-PR	\$138	

Spare Parts	Description	Measurements	Size	Part No.	USD Price	HCPCS
	<input type="checkbox"/> Complete set of upholstery w/splashguard, Blue		1	880181-61	\$455	
	<input type="checkbox"/> Complete set of upholstery w/splashguard, Blue		2	880182-61	\$455	
	<input type="checkbox"/> Complete set of upholstery w/splashguard, Blue		3	880183-61	\$455	
	<input type="checkbox"/> Complete set of upholstery w/splashguard, Blue		4	880184-61	\$455	
	<input type="checkbox"/> Complete set of upholstery w/splashguard, Gray		1	880181	\$455	
	<input type="checkbox"/> Complete set of upholstery w/splashguard, Gray		2	880182	\$455	
	<input type="checkbox"/> Complete set of upholstery w/splashguard, Gray		3	880183	\$455	
	<input type="checkbox"/> Complete set of upholstery w/splashguard, Gray		4	880184	\$455	
	<input type="checkbox"/> Seat Upholstery, Blue		1	880161-61	\$176	
	<input type="checkbox"/> Seat Upholstery, Blue		2	880162-61	\$176	
	<input type="checkbox"/> Seat Upholstery, Blue		3	880163-61	\$176	
	<input type="checkbox"/> Seat Upholstery, Blue		4	880164-61	\$176	

Spare Parts	Description	Measurements	Size	Part No.	USD Price	HCPCS
	<input type="checkbox"/> Back Upholstery, Blue		1	880171-61	\$156	
	<input type="checkbox"/> Back Upholstery, Blue		2	880172-61	\$156	
	<input type="checkbox"/> Back Upholstery, Blue		3	880173-61	\$156	
	<input type="checkbox"/> Back Upholstery, Blue		4	880174-61	\$156	

Prices in USD & is subject to change without notice
For Quotes and Orders please send completed Order Form to: sales.us@etac.com or fax: 1-800-760-0537

Etac
13137 Bleinheim Lane
Matthews, North Carolina 28105
+1 844-US-MOBILITY (844-876-6245)
www.etac.us.com

OF5300-ENG-REV.08

Creating Possibilities